

MODEL
B534



DESCRIPTION

The 12 key Z.series keypads are specially designed for public environment applications, such as vending machines, ticket machines, payment terminals, telephones, access control systems and industrial machinery with braille keys. Keys and front panel are built from chrome plated zinc alloy (Zamak) with high resistance to impact and vandalism and is also sealed to IP67.

1 MAIN COMPONENTS

- Frame and keys are made of RoHS approved zinc alloy material
- Conductive rubber with carbon granules
 - Contact resistance: $\leq 150\Omega$
 - Elastic force: 200g
- 1.5mm thickness UL approved printed circuit board with golden fingers

2 STRUCTURE DRAWING

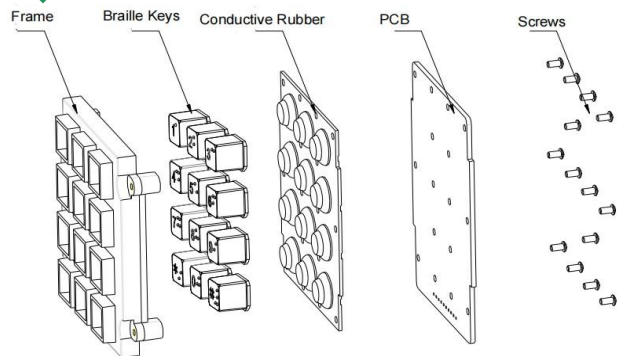

3 DIMENSION DRAWING

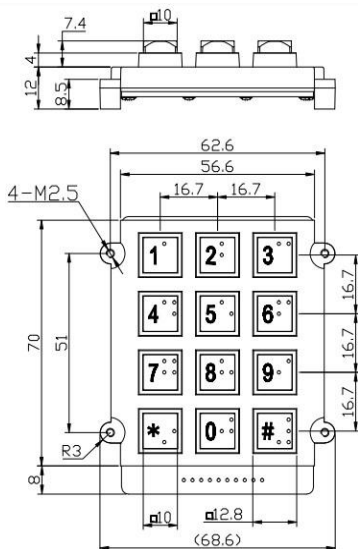

4 COMMON CIRCUIT

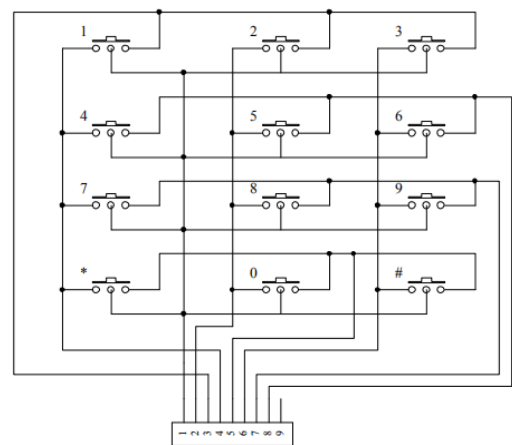

5 SPECIFICATION

Electrical Specification	Power Supply	Nominal 3 VDC
		Max. voltage 12VDC
		Min. voltage 3VDC
	Contact Resistance	≤150Ω
Mechanical Characteristics	Storage Temperature	-40 C ... +85 C
	Operation Temperature	-25 C ... +65 C
	Protection Grade	IP65
	Shock Resistance	IK09
	Electrical Life	1 million cycles of operation per key
	Key Travel	0.45mm
	Actuation Force	250g/2.45N
	Environmental Resistance	Damp heat 21 days +40 C
Saline mist 96 Hours		
Dry heat 10 days +85 C		

6 CONNECTOR

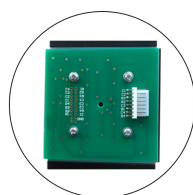

Plug Connector

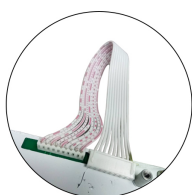

SCN plug+cable



XH plug+cable

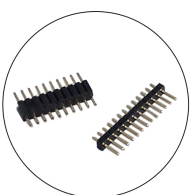

Pins header



DB9 Connector



USB

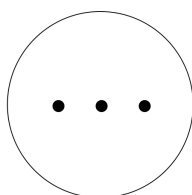

More

7 APPLICATION

